

# **Optical Instrumentation development:**

**Plenoptic cameras for denoising  
and optical systems for biology**

Jorge Tapia Farías, PhD.

# Outline

## INFRARED PLENOPTICS CAMERAS

- 1A. **Motivation 1:** Plenoptic imaging systems (IR)
- 2A. **Introduction:** Plenoptic cameras
- 3A. **Denoising by an Infrared plenoptic camera**

## OPTICAL TWEEZERS AND TRMFS

- 1A. **Motivation 2:** Measurement challenges in biology
- 2A. **Introduction:** Optical instrumentation for biology
- 3.A **Dual Optical Trapping and TRMFS for RBC membrane fluctuation**

- 4. **Conclusions and perspectives**

# INFRARED PLENOPTIC CAMERAS

# 1A. Motivation : Plenoptic imaging systems (IR)

Infrared image : Raw data

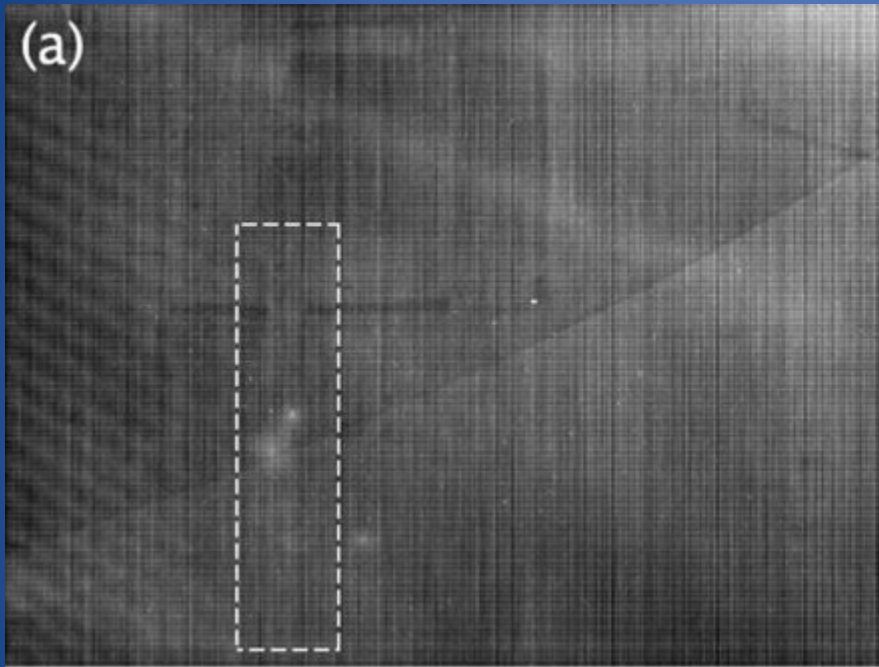

Corrected infrared image by traditional methods (linear correction)



## Noisy infrared images:

- Low energy photons
- Defects in sensor manufacturing

## Linear correction

We need precalibrate camera  
We need to know response of sensor previously

## 2A. Introduction: Plenoptic cameras

Matrix of images ( $L_f$ ): Plenoptic Data or Light Field



Fourier Slice Photography Operator: Plenoptic algorithm

$$\mathcal{P}_\alpha[L_f] = \mathcal{F}^{-2} \circ \mathcal{B}_\alpha \circ \mathcal{F}^4[L_f]$$



## 2A. Expected Result: Different objects plane in focus



### 3A. Denoising by an Infrared plenoptic camera

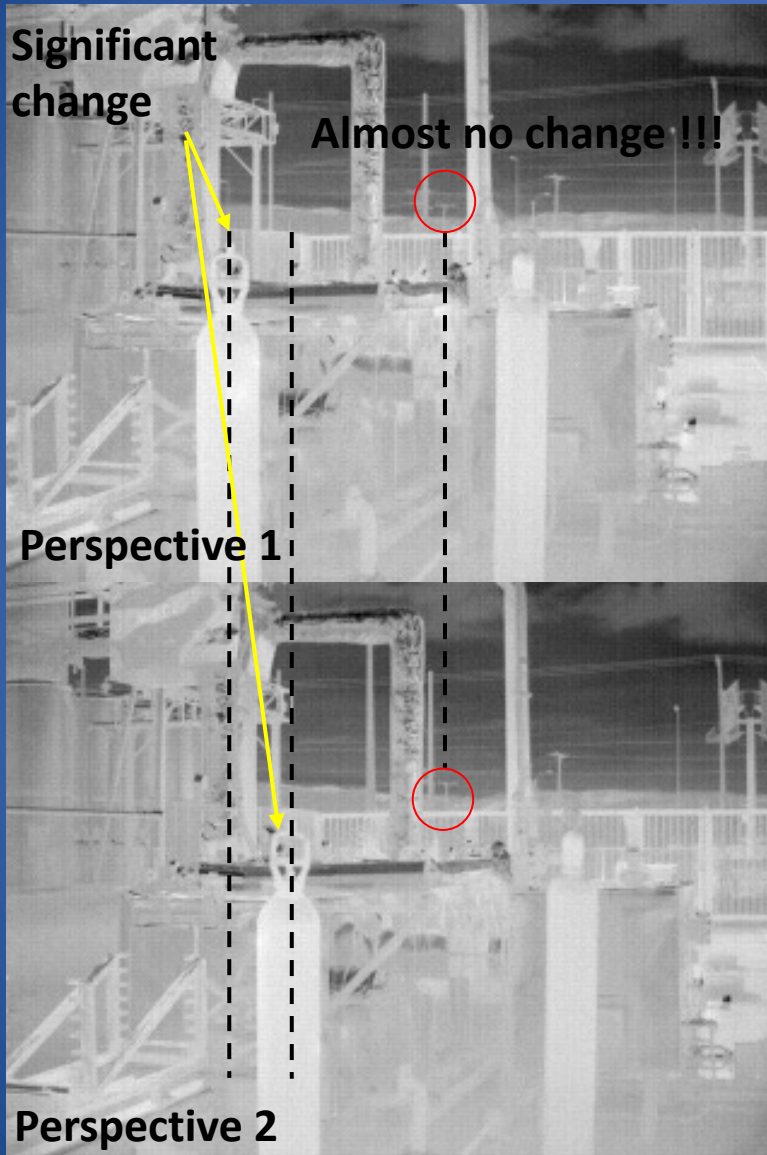

FPN no change from any perspective as object at infinity

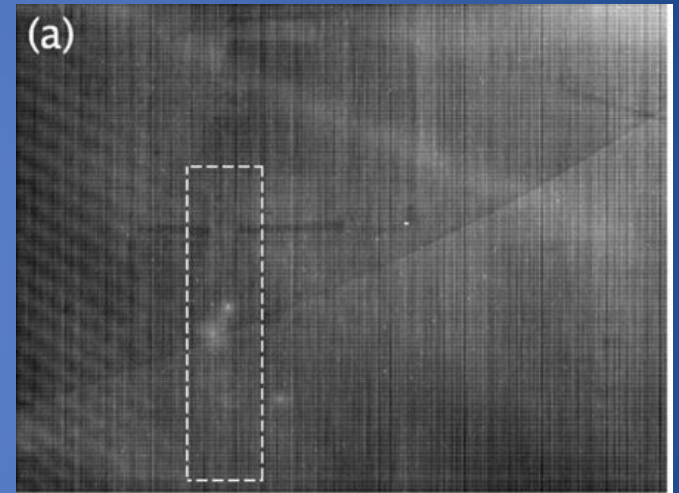

Under different perspectives, fixed pattern noise doesn't move between different perspectives, hence, it behaves like an object in infinity

# 3A. Set-up: Infrared plenoptic camera

## Acquisition Method

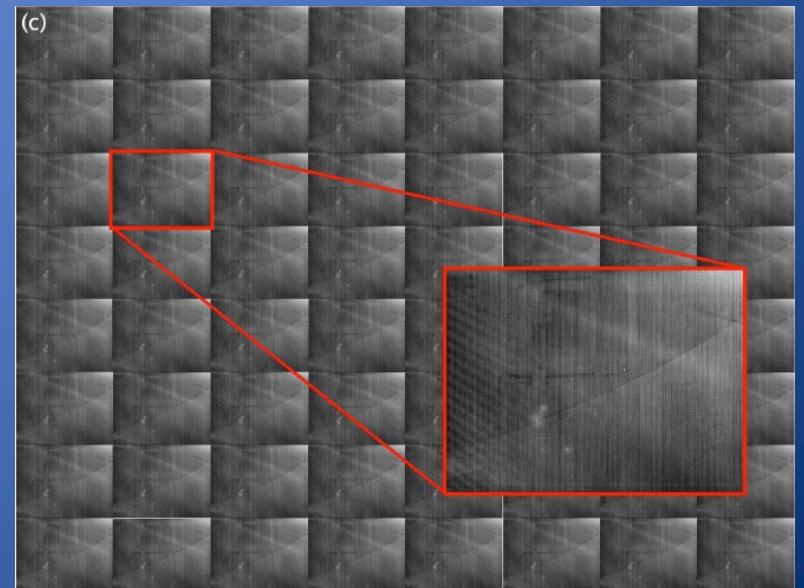
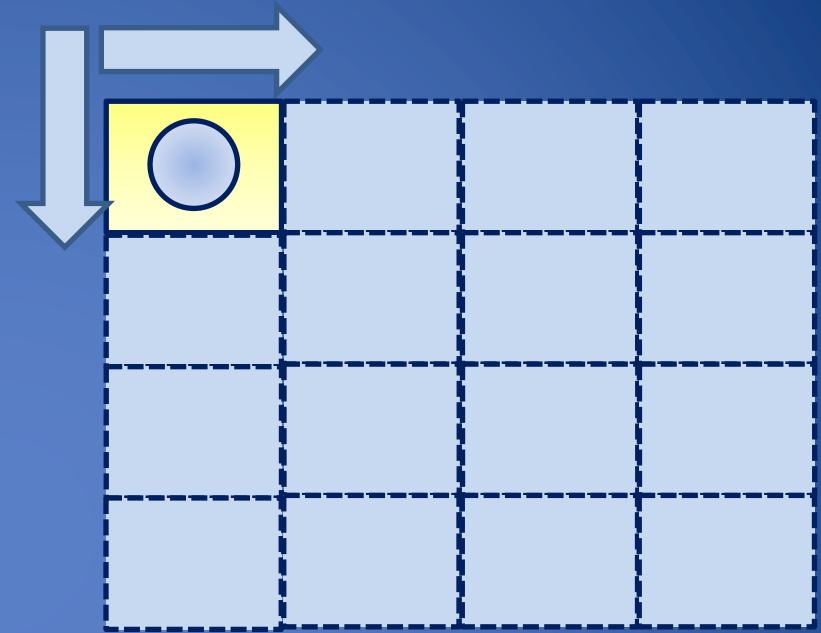
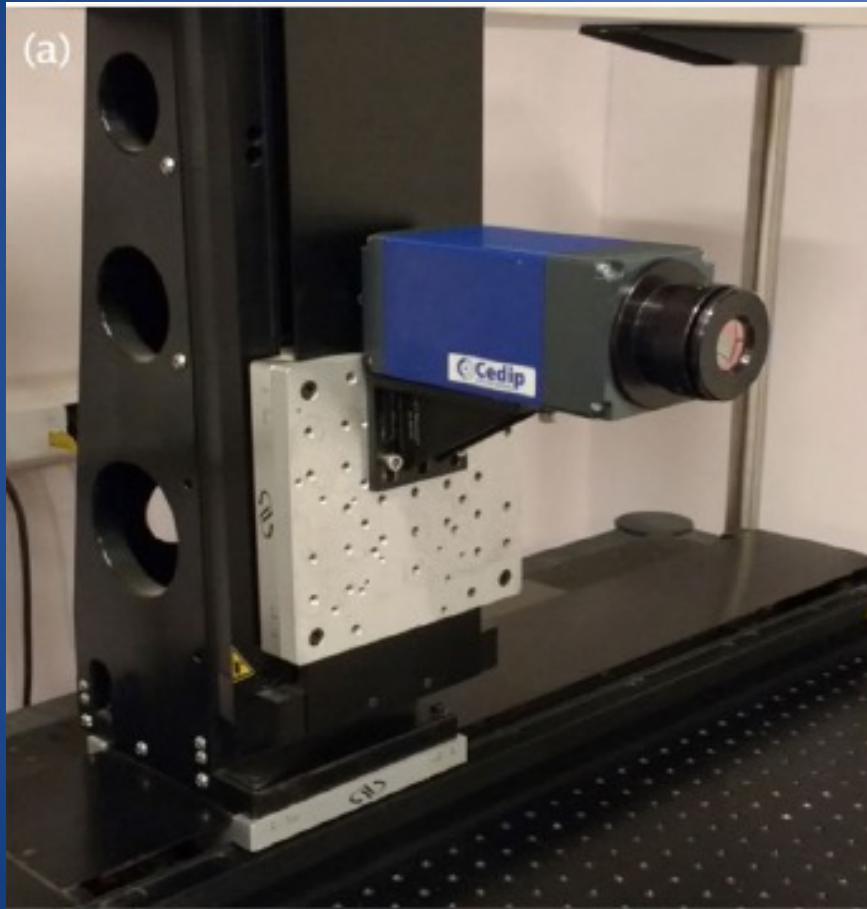



## 3A. RESULTS:

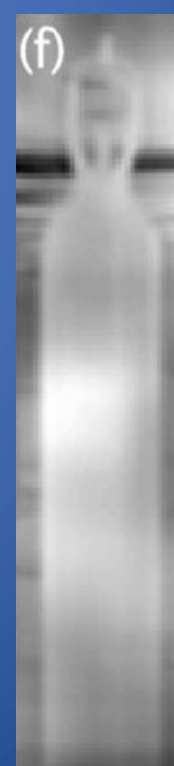
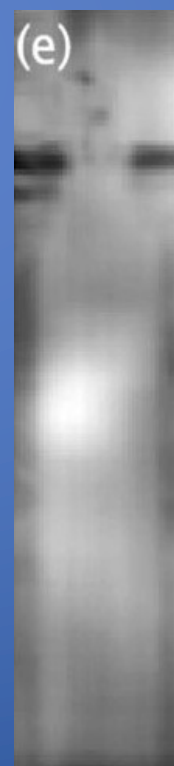
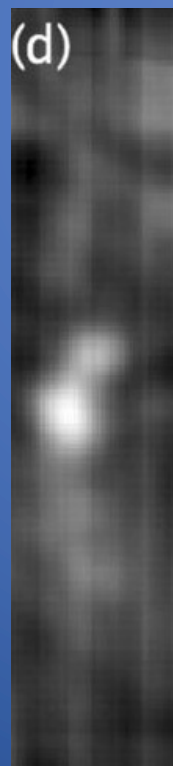
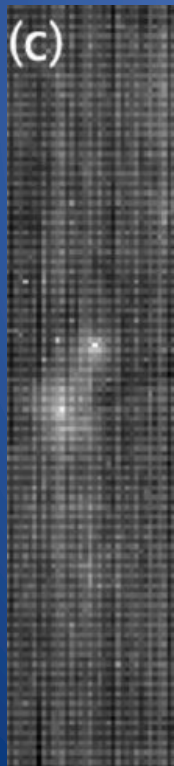
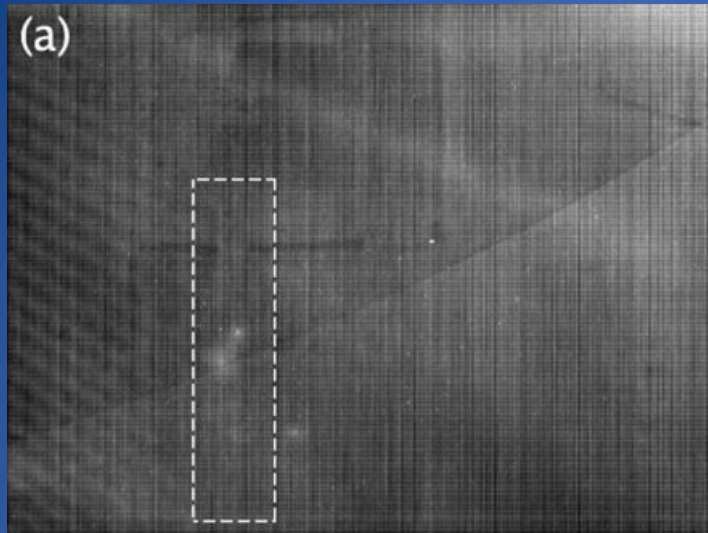

# BIOLOGY

- Optical Tweezers
- Time resolve membrane fluctuation Spectroscopy

# 1B. Motivation: Measurement in biological systems

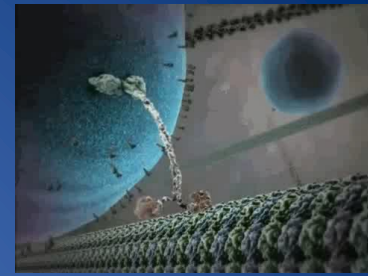

Proceso	$\Delta x_{step}$ (nm)	Instrumentation	Ref.
<i>Kinesin</i> moves along microtubules	$8.3 \pm 0.2$	Single OT	[1]
<i>RNA polymerase (RNAP)</i> moving in DNA transcription	$0.37 \pm 0.06$	Dual OT	[2]
<i>Red blood cells Membrane Fluctuation</i>	$34.0 \pm 0.7$	Single TRMFS	[3]

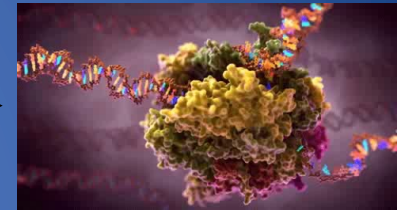

We need instrumentation with resolution as high as possible



- Optical Tweezers
  - (OT)



Time resolve membrane fluctuation spectroscopy  
(TRMFS)

# 2B. Introduction: Optical instrumentation for biology

## DUAL OPTICAL TRAP

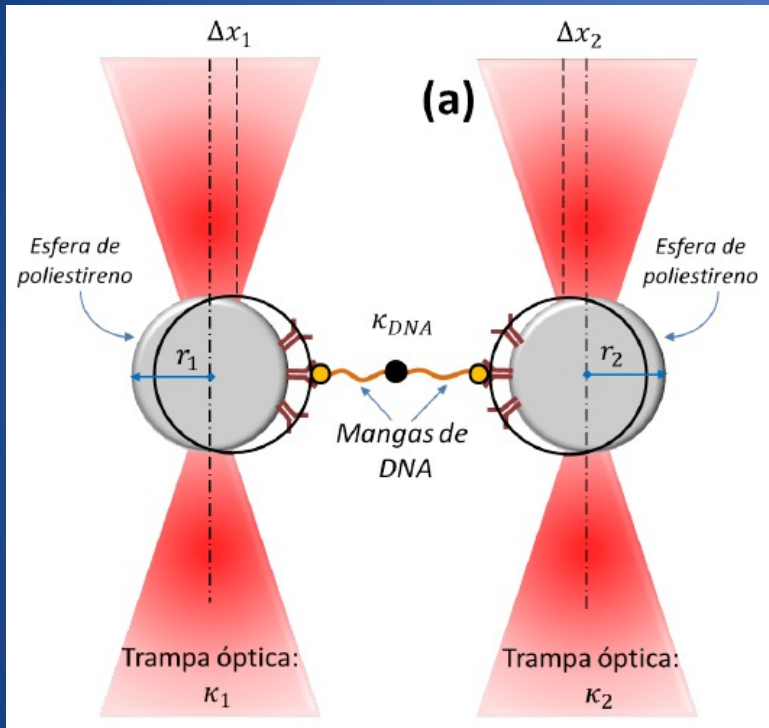

$$x_- = x_1 - x_2 \quad \text{Differential coordinate}$$

**SNR de coordenada diferencial**

$$SNR_{diff} = \frac{\langle \Delta x_- \rangle}{\langle x_-^2 \rangle_B}$$

$\langle \Delta x_- \rangle = \langle \Delta x_1 \rangle - \langle \Delta x_2 \rangle$

$\langle x_-^2 \rangle_B = \langle x_1^2 \rangle_B + \langle x_2^2 \rangle_B - 2 \langle x_1 x_2 \rangle_B$

**Positive correlation**

Figura 4. Dual Optical Trap.

## 2B. TIME RESOLVE MEMBRANE FLUCTUATION SPETROSCOPY (TRMFS)

### Single TRMFS

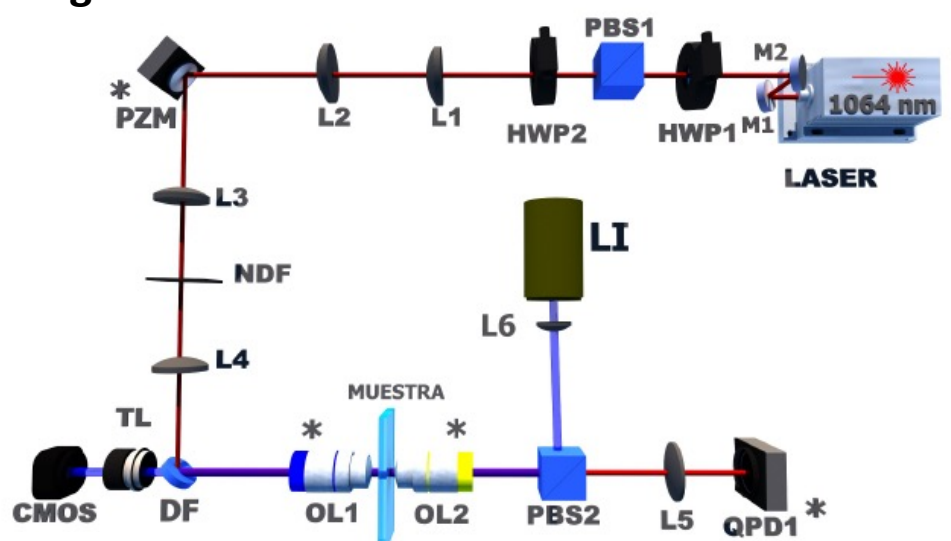

### Dual TRMFS

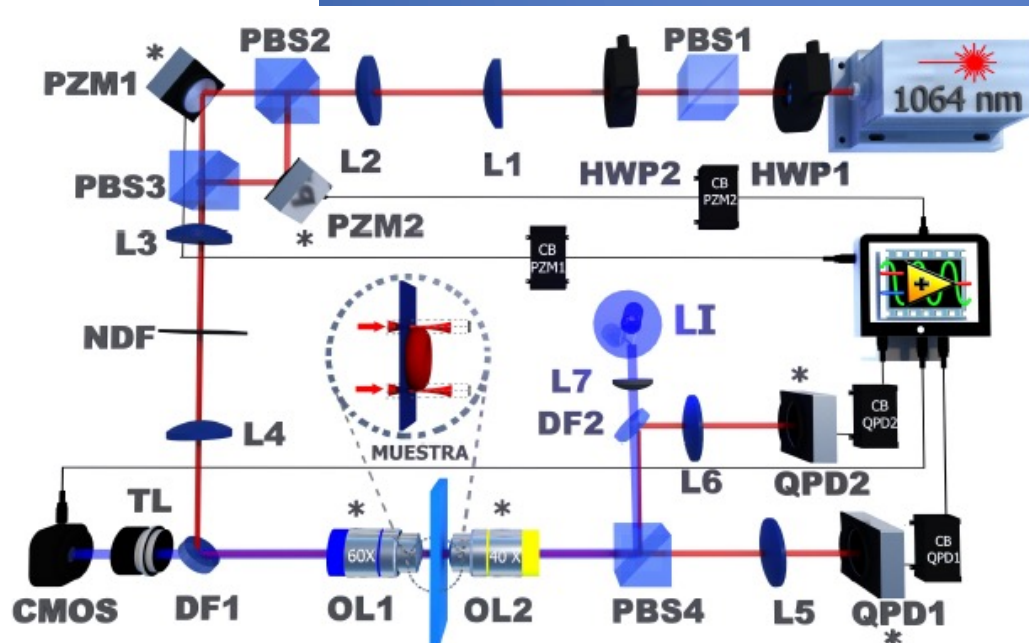

### Single TRMFS

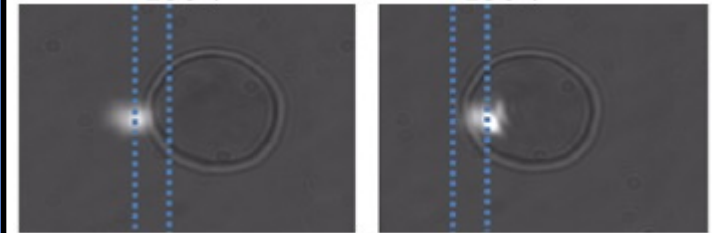

### Dual TRMFS

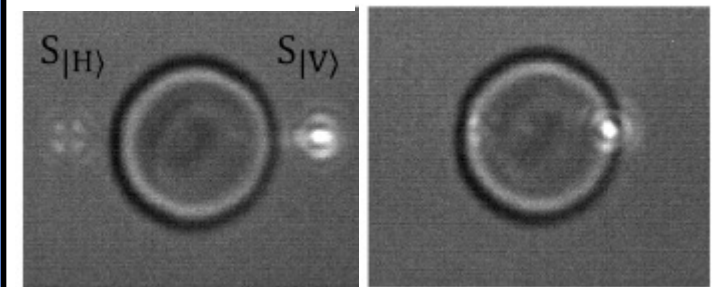

$$\begin{aligned} \text{PSD}_{\omega \rightarrow 0} &= \frac{k_B T}{2\sigma\omega} \\ &= \frac{k_B T}{2\sigma(2\pi f)^2} \\ \text{PSD}_{\omega \rightarrow \infty} &= \frac{k_B T}{6\pi(2\eta^2\kappa)^{1/3}\omega^{5/3}} \\ &= \frac{k_B T}{6\pi(2\eta^2\kappa)^{1/3}(2\pi f)^{5/3}} \end{aligned}$$



# 3B. RESULTS: DUAL OPTICAL TWEEZERS:

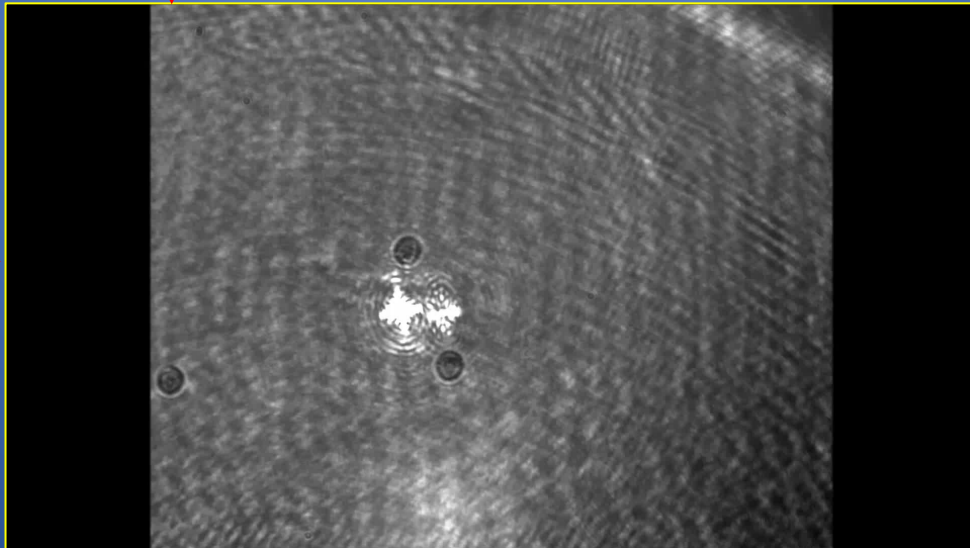
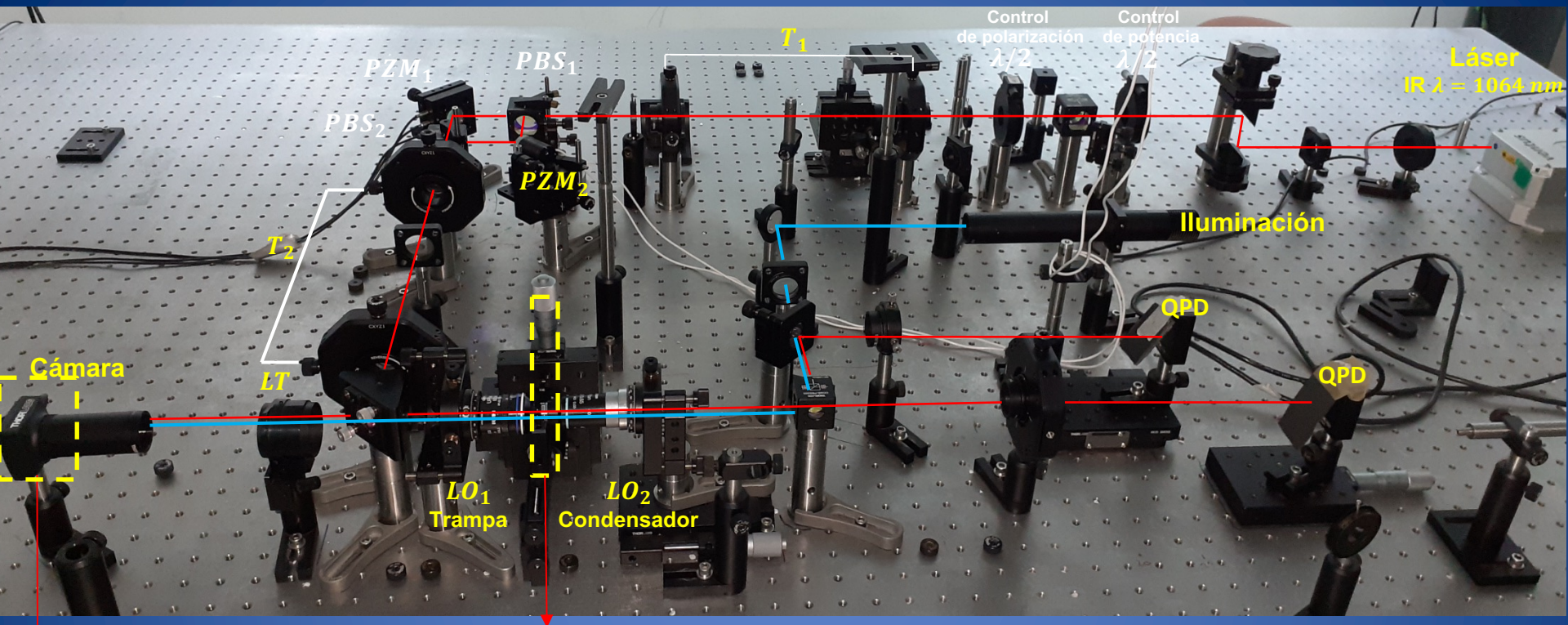

Sample plane

### 3B. RESULTS: Single and dual TRMFS:

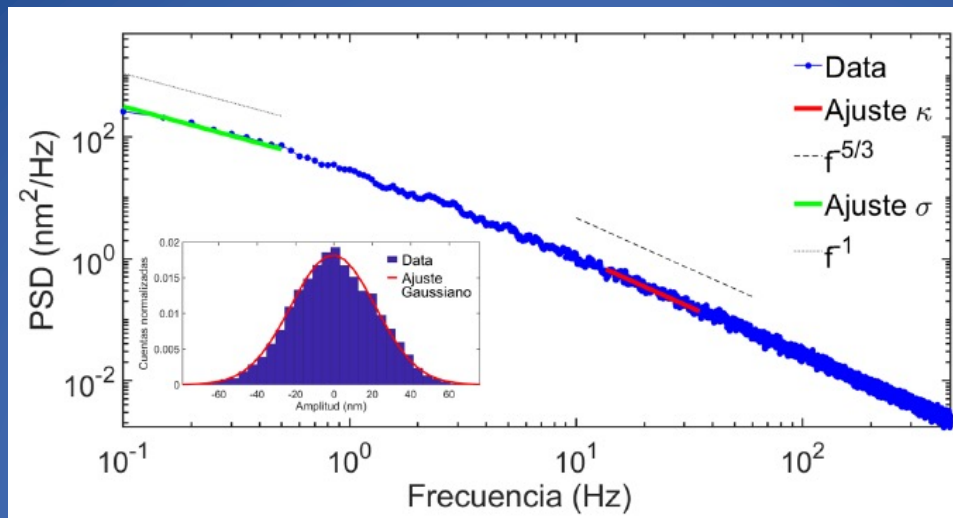

Research on  
**resveratrol**  
protective effects

	Control	HClO	RV	RV + HClO
STD (nm)	$28.6 \pm 2.6$	$18.6 \pm 1.7$	$29.6 \pm 2.5$	$21.7 \pm 1.4$
$\kappa$ ( $10^{-19}$ J)	$2.2 \pm 0.4$	$3.6 \pm 0.5$	$1.2 \pm 0.3$	$2.9 \pm 0.6$
$\eta_{\text{eff}}$ ( $10^{-3}$ Pa $\times$ s)	$86.3 \pm 0.8$	$85.1 \pm 0.9$	$85.9 \pm 1.0$	$83.1 \pm 1.1$

Research on  
Different **Glucose**  
Concentrations

Señal	Parámetro	5.5 mM	12.5 mM	25 mM
$S_{ V\rangle}$	Amplitud (nm)	$24.66 \pm 0.38$	$27.50 \pm 0.49$	$27.68 \pm 0.55$
	$\kappa$ ( $10^{-19}$ J)	$9.79 \pm 0.78$	$6.75 \pm 0.59$	$5.87 \pm 0.63$
	$\sigma$ ( $10^{-6}$ N/m)	$11.85 \pm 0.55$	$9.05 \pm 0.39$	$9.35 \pm 0.50$
$S_{ H\rangle}$	Amplitud (nm)	$26.81 \pm 0.35$	$28.69 \pm 0.46$	$28.25 \pm 0.52$
	$\kappa$ ( $10^{-19}$ J)	$7.07 \pm 0.52$	$6.40 \pm 0.61$	$5.33 \pm 0.44$
	$\sigma$ ( $10^{-6}$ N/m)	$9.89 \pm 0.51$	$8.36 \pm 0.39$	$9.11 \pm 0.50$



# Related publications and productivity

## Publication 1

Coelho, P. A., Tapia, J. E., Perez, F., Torres, S. N., & Saavedra, C. (2017). Infrared light field imaging system free of fixed-pattern noise. *Scientific reports*, 7(1), 13040. doi.org/10.1038/s41598-017-13595-7

## Publication 2

Gallardo, M. J., Suwalsky, M., Ramírez, D., Tapia, J., & Sepulveda, B. (2019). Antioxidant effect of resveratrol in single red blood cells measured by thermal fluctuation spectroscopy. *Archives of biochemistry and biophysics*, 665, 30-35. doi.org/10.1016/j.abb.2019.02.011

## Publication 3

Tapia, J., Vera, N., Aguilar, J., González, M., Sánchez, S. A., Coelho, P., ... & Staforelli, J. (2021). Correlated flickering of erythrocytes membrane observed with dual time resolved membrane fluctuation spectroscopy under different D-glucose concentrations. *Scientific reports*, 11(1), 1-12.

## Patent 1: US

RUBILAR, C. S., INOSTROZA, S. N. T., CARO, P. A. C., FARIAS, J. E. T., & VENEGAS, F. G. P. (2021). *U.S. Patent No. 10,891,716*. Washington, DC: U.S. Patent and Trademark Office.

## Patent 2: INAPI, Chile

Saavedra, C., Torres, S., Coelho, P., Tapia, J., & Pérez, F. (2018). Un proceso que permite eliminar el ruido de patrón fijo en imágenes efectivas formadas por arreglos de sensores electromagnéticos en un campo de luz mediante un reenfoque digital. N° de Patente: 55615. Chile; Instituto Nacional de Propiedad Industrial (INAPI).

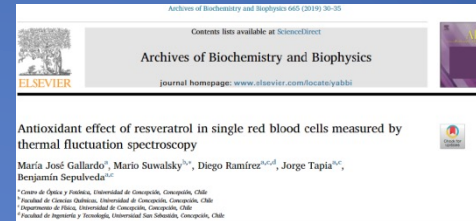
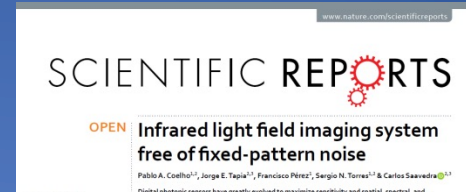

## 4. Conclusions and perspectives

IR Plenoptics cameras could be an relevant alternative to decrease its cost of calibration and make easier this process

Dual TRMFS must to be studied deeper in terms of correlation and the possible improvements of spatial resolution applied to fluctuation measurements.

THANKS  
TO EVERYONE